

# INSTALLATION INSTRUCTIONS

## GLAZE GLADIATOR SYSTEM SERIES GLADIATOR SLIDING DOOR KIT.



Phone: (813) 922-2309  
[glazehardware.com](http://glazehardware.com)

***Please keep this manual and the product code number for future reference and to order replacement parts if necessary***

## GENERAL INSTRUCTIONS

- Please read this manual carefully and thoroughly before proceeding.
- For your safety, it is recommended that you wear safety glasses at all times during installation.

## INSTALLATION OVER CERAMIC TILES

- If you are installing the shower door over ceramic tiles, make sure that the tiles lay completely under the wall jamb.
- Use mildew resistant silicone to seal the gaps where the ceramic tiles meet the fixed panel.







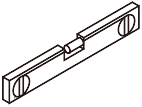

## NOTICE

- Caulking is not required inside the shower, unless otherwise stated.
- Some models are equipped with clear sealing gaskets.

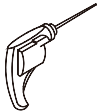
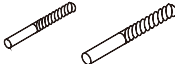
## CARE FOR YOUR SHOWER DOOR

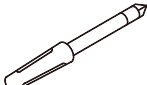
- Do not use scouring powder pads or sharp instruments on metal pieces or glass panels.
- To keep the panels and metal parts looking new, occasionally wipe them down with a mild soap diluted in water.
- We recommend wiping the glass panels with a squeegee after each use.

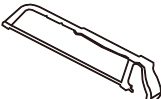
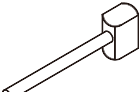
## TOOLS REQUIRED

 SPIRIT LEVEL	 TAPE MEASURE	 POWER DRILL	 DRILL BITS	 SILICONE
 SCREW DRIVER	 PENCIL	 HACKSAW	 MALLET	 SAFETY GLASSES



2 PEOPLE REQUIRED

Product specifications are subject to change without notice.









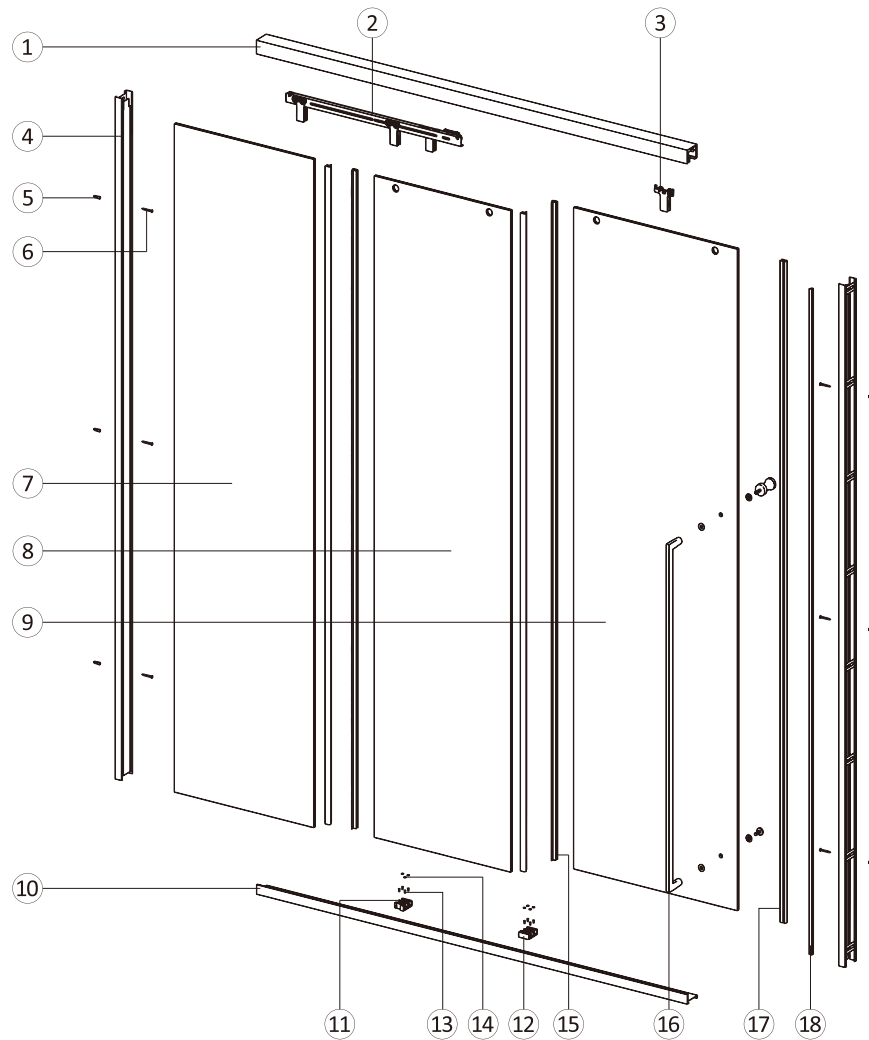









## GLADIATOR SLIDING DOOR KIT.



\*Our products are available in a variety of colors and sizes to suit your needs.

## PARTS LIST



ITEM	PARTS	DIAGRAM	QTY	ITEM	PARTS	DIAGRAM	QTY
1	Header bar		1	10	Threshold		1
2	Pulley system		1	11	Bottom guide		1
3	Pulley		1	12	Bottom guide		1
4	Wall profile		2	13	Screw St4x6		8
5	Wall anchor Ø6		6	14	Bottom guide cover		8
6	Screw St4x30		6	15	Plastic seal		4
7	Fixed panel		1	16	Handle		1
8	Sliding door		1	17	Plastic seal		1
9	Sliding door		1	18	Decorative strip		1

## PARTS LIST

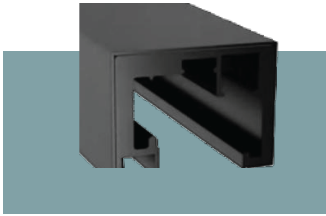

■ Aluminum Header Bar



■ Side Profile  
304 Stainless Steel

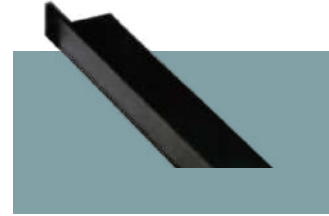

■ Threshold  
304 Stainless Steel



■ Pulley



■ Bottom Guide



■ 40 Handle  
Ø304 Stainless Steel



■ Bottom Guide

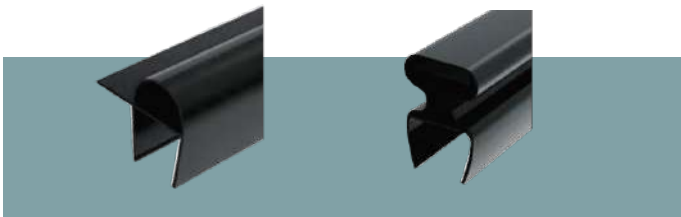

■ Plastic Strip

## SECTION DIAGRAM

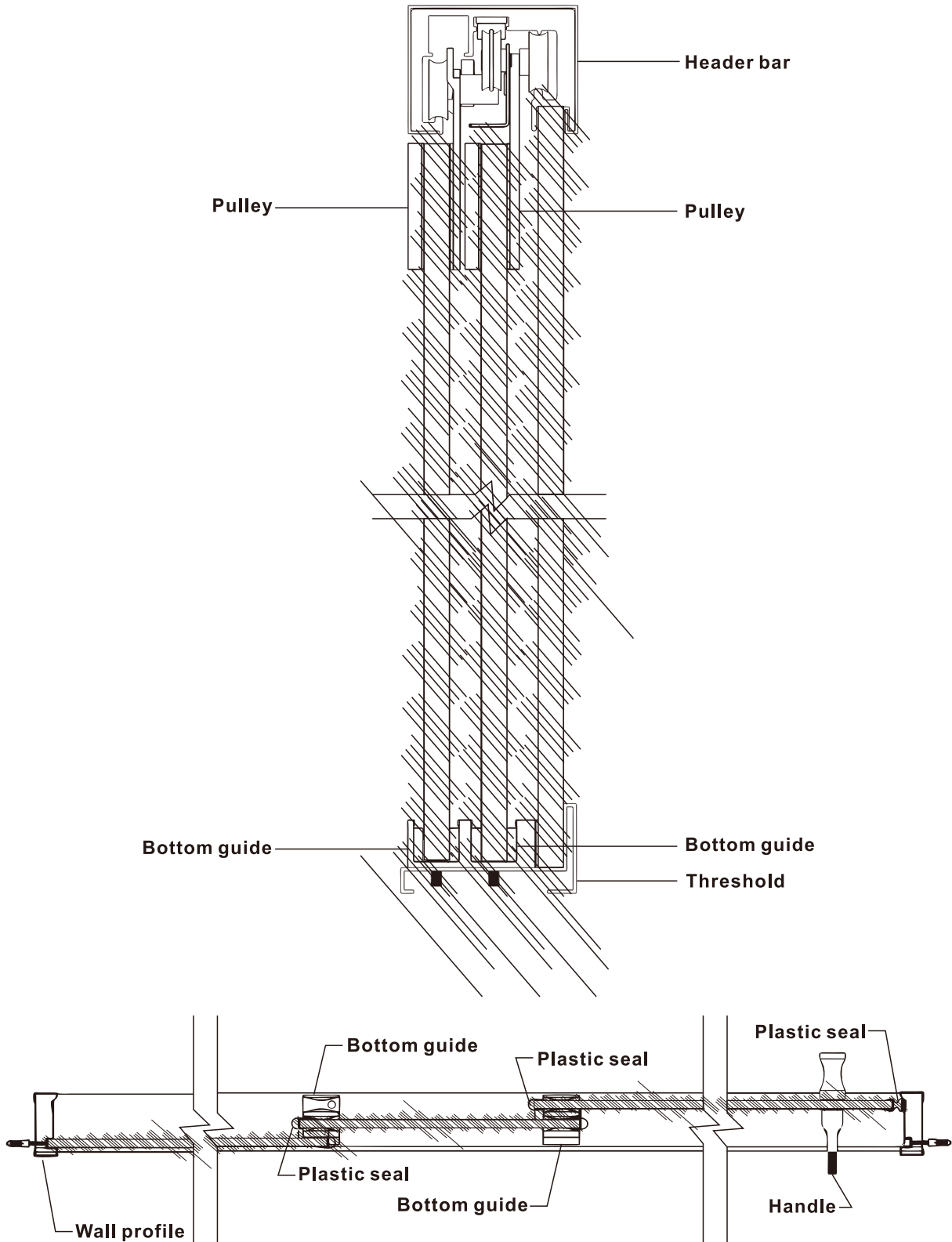

## STEP 1



**Left-Opening**



**Right-Opening**

\*This product is available in both left-opening and right-opening door configurations. Please verify which version you have purchased before installation. This installation guide is intended for right-opening shower doors.

## STEP 2

### Installation of wall profile and threshold



\***Note:** Depending on the door opening direction, cut the bottom rail precisely as indicated by the arrow on the label to ensure proper fit and alignment.

\*Use a pen to mark the cutting area, then carefully cut along the mark using a saw or cutting tool. Make sure the blade is accurately aligned with the mark before starting the cut.

## STEP 3

### Installation of wall profile and threshold



\*Before installing the wall profile, check that the magnetic strip is attached to the back. Then, position the grooved side of the profile facing outward.



\*Position it onto the bottom slot, ensuring proper alignment. Use a spirit level or laser level to measure, and adjust the wall material as needed to maintain equal measurements on both sides.

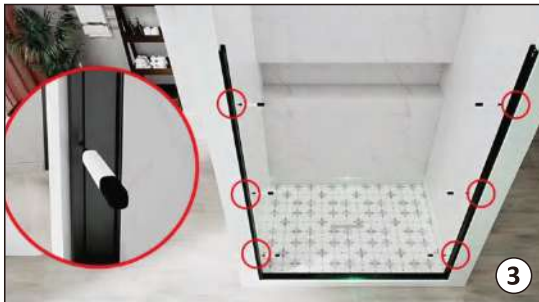

\*Mark these positions with a pen, making sure the marks are precise and clear to ensure accurate positioning during the drilling process.

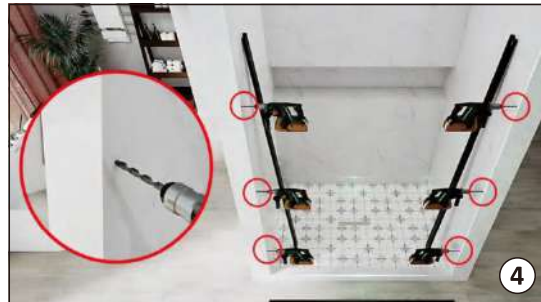

\*Attach a 1/4" drill bit securely to the electric drill. Drill carefully at the marked locations. When drilling into tiles, use a slow speed to avoid cracking.



\*Insert the wall anchor firmly into the hole.

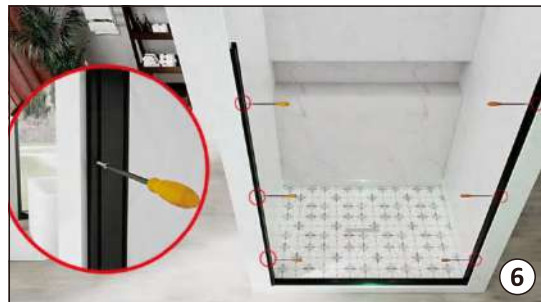

\*Reposition the wall profile and use a screwdriver to securely tighten the screws, ensuring it is firmly fixed to the wall.

## STEP 4

### Installation of fixed panel and bottom guide



\*Carefully place the two glass panels inside, taking precautions to prevent damage from tilting or impact. Ensure the glass is properly protected through out the process.



\*Carefully insert the fixed glass into the slot, making sure it is stable and firmly seated. The installation is considered complete only when the glass is securely in place.



\*Insert the trim strip into the slot of the right-hand door.



\*Install the fixed glass bottom guide.



\*Precisely install the bottom guide with the locking notch onto the glass edge. Its unique notched design creates a secure fit, offering support and stability to prevent any movement or wobbling.



#### ATTENTION

The bottom guide comes pre-installed in the bottom rail before shipping. Please refer to the video above to complete the glass installation.

## STEP 5

### Installation of pulley

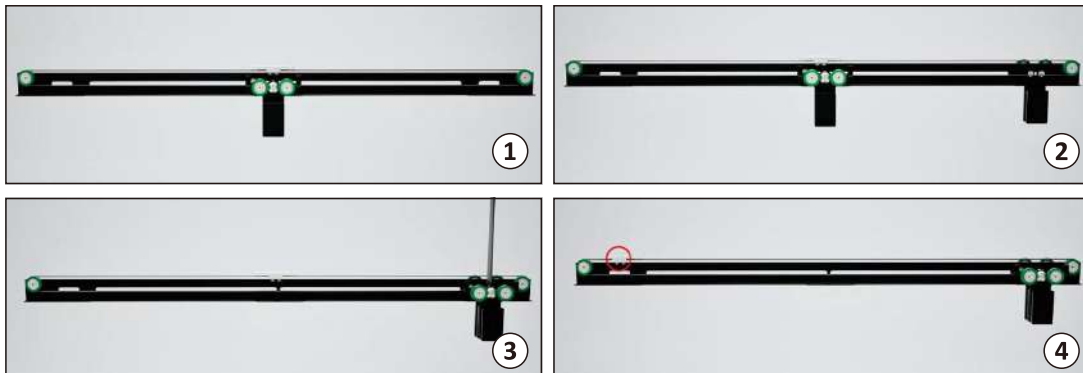

\*Mount the pulley onto the short locking notch on the right side, align the other pulley parallel to it, and then securely tighten the screws.

\*Shift the fixed component to the opposite side, aligning it perpendicular and parallel to the short locking notch.



\*Mount the pulleys onto the long locking notch, making sure the distance between their centers aligns with the hole spacing on the middle glass panel.

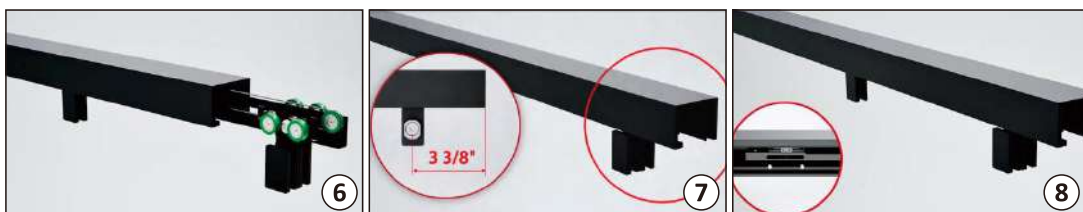

\*Once assembled, insert them into the aluminum profile. Note that the distance from the pulley center to the edge is 3 3/8\".

\*Finally, secure the installation by tightening the two screws on the fastener.

#### ATTENTION

All the above steps have been completed and adjusted before the product is shipped. Under normal conditions, no further adjustments are required, allowing for direct installation. However, if minor misalignments occur between the pulleys and the hole spacing on the middle glass panel, adjustments can be made during installation by following the steps outlined above.

## STEP 6

### Installation of header bar

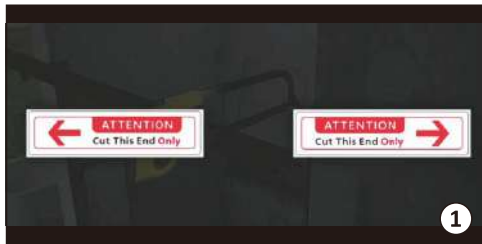

\*Important: Because the door opens in different directions, a label is placed on the marked section of the header bar. Please follow the direction indicated on the label when making the cut.

\*Use a saw to cut the aluminum profile to the required length, making sure the edges are clean and smooth.

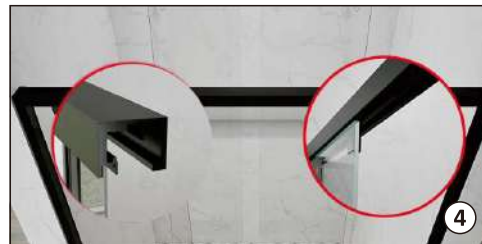

\*Please note that a directional label is attached to the top rail. Make sure the channel side faces outward during installation to ensure precise alignment with the fixed glass, providing a secure and stable fit.

## STEP 7

### Installation of glass and pulley



\*Please reposition the hanging clamps to the correct location. This will ensure there is sufficient space for the glass during installation and prevent any unnecessary obstructions.

\*Detach the pulley cover and screws from the linkage assembly.



\*Next, install the middle sliding glass door. Verify that the bottom guide slot is properly aligned and the pulley is securely seated. Then, tighten the screws and attach the decorative cover to complete the installation.

## STEP 8

### Installation of glass and pulley



\*Disassemble the single pulley component.



\*Mount the pulley component onto the sliding track.



\*Carefully lift and install the final glass panel, aligning it precisely with the slot in the bottom guide.



\*First, align the mounting holes on one side of the glass. Then, adjust the single pulley to precisely match the glass holes before securing it with screws.



\*Use a wrench to adjust the eccentric wheel, which features a notch to indicate whether the glass is level.



\*Once adjustments are complete, secure the installation by placing the decorative cap.

## STEP 9

### Installation of glass door handle



\*Install the handle using the pre-drilled holes in the glass. Before inserting the handle, make sure to place plastic washers on both the inner and outer sides of the glass. Tighten firmly to ensure a secure, wobble-free fit.

## STEP 10

### Installation of plastic seal



\*Install the sealing strips according to the color coding shown in the image. Please note that the red-marked sealing strip contains magnets and should be installed on the handle side.

## STEP 11

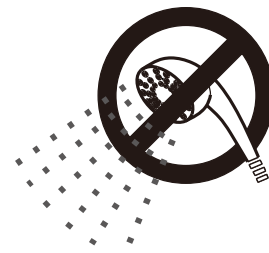

**24** HOURS

\*Wait 24 hours for the glass adhesive to cure.